

CARBON STEEL BALL VALVE

TBAC-RP SERIES

FEATURES

- 2500 / 3000 / 5000 WOG Standar port.
- Cast steel body.
- Blow out proof stem.
- Delrin / Molon seat.
- Inspection and test: AP1598.
- Threads conform to ASME B1.20.1 (NPT).
- NACE MR-01-75.



Parts and Materials

#	Description	Material
1	Body	ASTM A216 WCB
2	Body Seal	Viton
3	Adaptor	ASTM A216 WCB
4	Seats	Delrin
5	Ball	SS420
6	Stem	ASTM A276 420
7	Thrust Bearing	PTFE
8	Stem Seal	Viton
9	Stem Seal	Viton
10	Stem Bearing	PTFE
11	Stop Plate	Steel Plate
12	Pin with Chain	Stainless Steel
13	Retainer Ring	Spring Steel
14	Stop Pin	Spring Steel
15	Hexagon Bolts	Carbon Steel
16	Grease Zerk	Carbon Steel
17	Handle	Ductile Iron

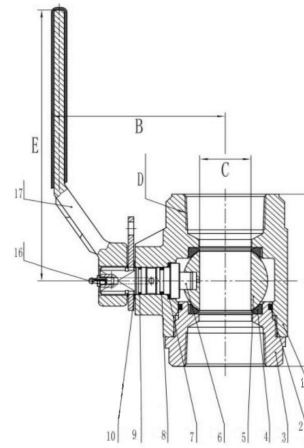
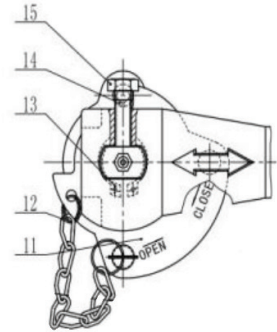

Dimensions

Size	#	Connection	Pressure	Kg	A	B	C	D	E
inch				lbs	inch	inch	inch	inch	inch
2	TBAC09L25	RP	2500	12.15	5.51	5.53	1.50	11.5NPT	10
2	TBAC09L30	RP	3000	12.15	5.51	5.53	1.50	11.5NPT	10
2	TBAC09L50	RP	5000	12.83	5.51	5.12	1.50	11.5NPT	10
3	TBAC11L30	RP	3000	23.02	8.24	5.93	2.02	8NPT	10
4	TBAC12L20	RP	2000	42.90	8.72	6.87	3.02	8NPT	15

Pressure Temperature Ratings

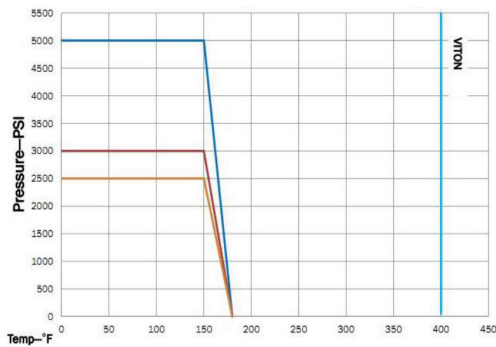

Please Note: We reserve the right to make technical changes without notice.

CARBON STEEL BALL VALVE

TBAC-RP SERIES

FEATURES

- Blowout proof stem, Locking Pin W/ Chain.
- External stem lubrication, W/ FxF (NPT) End Connections.
- 1" - 3" Standard W / Lever, 4" standard W / T-Bar.



Specifications

Size	1" - 4" including 2" - 12"
Style	2pc Body, Tank Valve
Port	Full Port
Design	ASME B16.34
Materials	NACE MR-0175
Working Pressure	3000-50000 WOG / (NSCWP)
Inspection and Test	API598
Threads Conform To	ASME B1.20.1

Parts and Materials

#	Description	Material
1	Body	ASTM A216 WCB
2	Body Seal	Viton
3	Adaptor	ASTM A216 WCB
4	Seats	Delrin
5	Ball	ASTM 420SS
6	Stem	ASTM A276 420SS
7	Thrust Bearing	PTFE
8	Stem Seal	Viton
9	Stem Seal	Viton
10	Stem Bearing	PTFE
11	Stop Plate	Steel Plate
12	Pin with Chain	Stainless Steel
13	Retainer Ring	Spring Steel
14	Stop Pin	Spring Steel
15	Hexagon Bolts	Carbon Steel
16	Grease Zerk	Carbon Steel
17	Handle	Ductile Iron

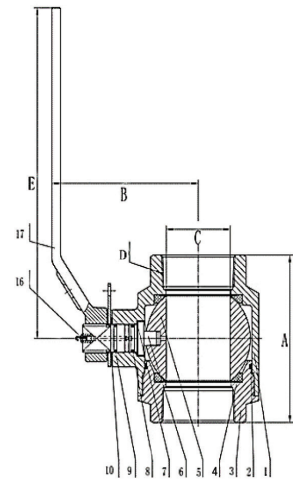
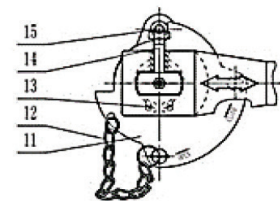

Dimensions

Size	#	Crate Qty	Torque	 Kg	A	B	C	D	E
inch			in / lbs	lbs	inch	inch	inch	inch	inch
1	TBAC06L50F	100	1500	5	4.06	4	1.03	11.5NPT	6
2	TBAC09L30F	100	2350	19	6	5.93	2.02	11.5NPT	10
2 1/2	TBAC10L30F	50	3200	33	7	6.35	2.56	8NPT	15
3	TBAC11L30F	30	4100	55	8.72	7.39	3.02	8NPT	20
4	TBAC12L30F	16	8100	83.5	9.37	9.76	4.06	8NPT	31.50

Please Note: We reserve the right to make technical changes without notice.

CARBON STEEL BALL VALVE

TBAC-RP SERIES

Pressure Temperature Ratings

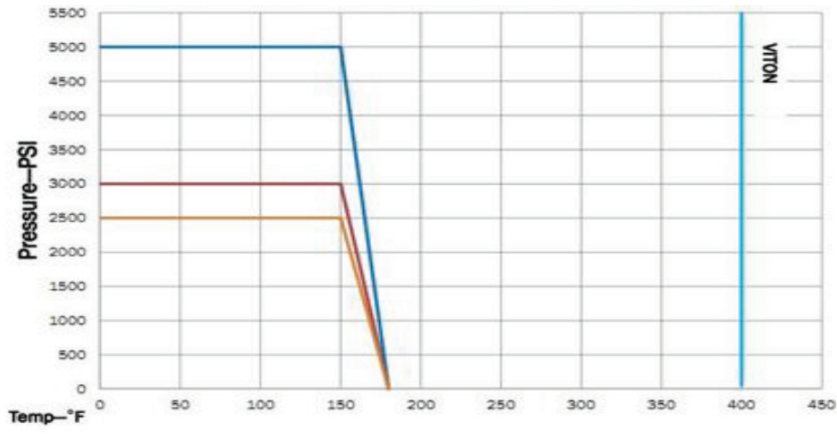

Please Note: We reserve the right to make technical changes without notice.